

HunterDouglas

Installation • Operation • Care



**Designer Roller and
Designer Screen Shades**

Standard and Cassette Cordless Lifting System

CONTENTS

Getting Started:

Product Views	1
Tools and Fasteners Needed	3
Installation Overview	3

Installation:

Mounting Types and Window Terminology	4
Mount the Installation Brackets — Inside or Ceiling Mount for Standard Shades ...	4
Mount the Installation Brackets — Outside Mount for Standard Shades	5
Mount the Installation Brackets — Inside or Ceiling Mount for Cordless Cassette..	6
Mount the Installation Brackets — Outside Mount for Cordless Cassette	7
Install the Shade	8
Install the Shade Pull	9
Attach the Standard Hold-Down Brackets (Optional)	9
Attach the Magnetic Hold-Down Brackets (Optional)	10

Operation:

Operate the Shade	11
Shade Adjustment	11
Troubleshooting	13

Care:

Removing the Shade (If Necessary)	14
Cleaning Procedures	14

Questions?

Call the Hunter Douglas Customer Information Center at
1-888-501-8364.



Product Views

Standard Cordless

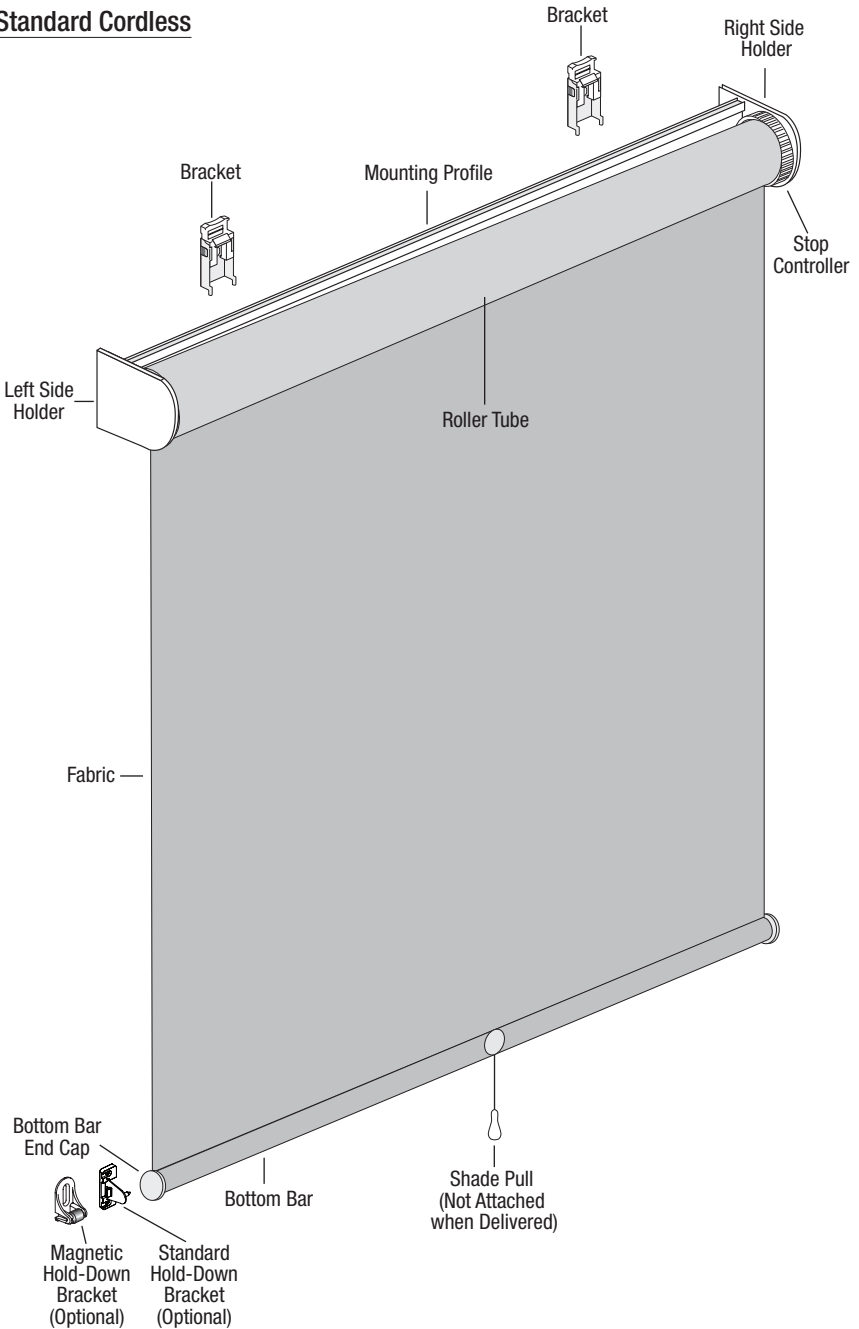

GETTING STARTED

Product Views

Cassette Cordless

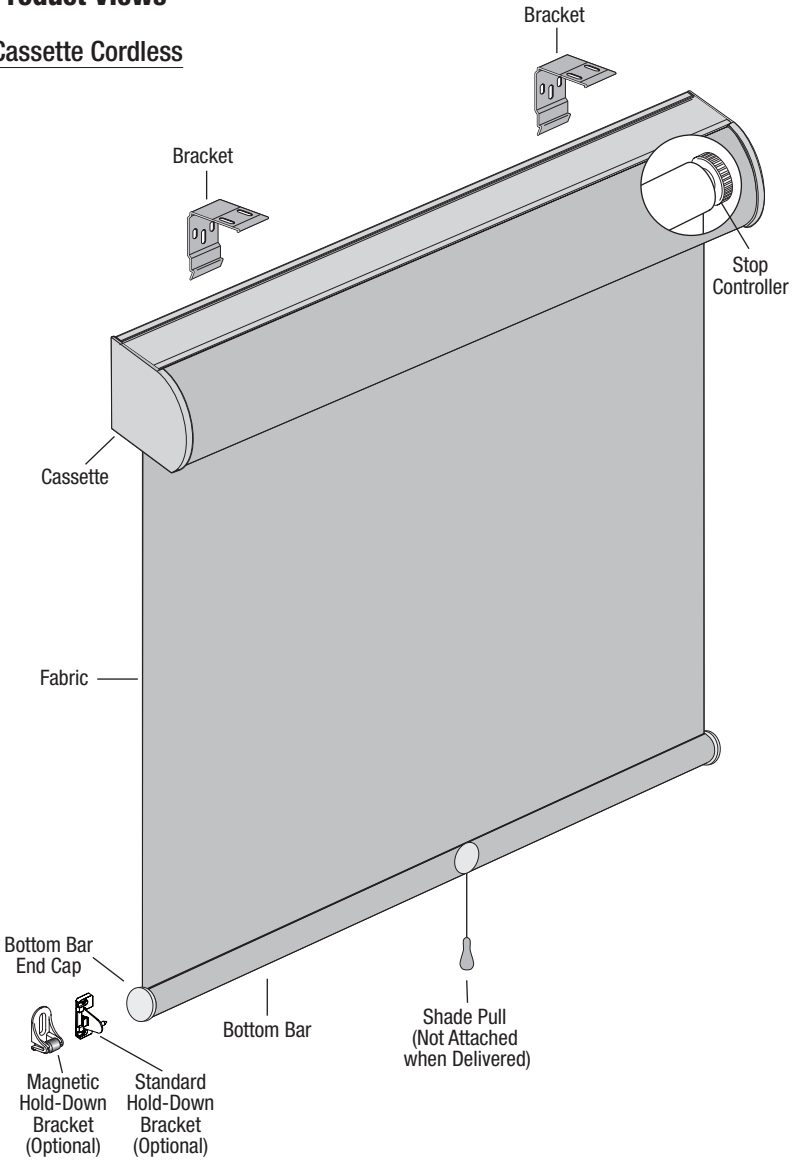

Thank you for purchasing Hunter Douglas Designer Roller and Designer Scene Shades. With proper installation, operation, and care, your new shades will provide years of beauty and performance. Please thoroughly review this instruction booklet before beginning the installation.

Tools and Fasteners Needed

- Flat blade and Phillips screwdriver
- Level (laser level is recommended)
- Measuring tape and pencil
- Power drill, $\frac{3}{32}$ " drill bit and a $\frac{1}{4}$ " hex driver

In addition, you will need fasteners designed to work with your specific mounting surface(s).

- **#6 Hex Head Screws (Provided).** Two 1½" screws are provided per installation bracket.
- **Drywall Anchor (Not Provided).** Use drywall anchors when mounting into drywall.



#6 x 1½"
Hex Head Screw
(Provided)

Installation Overview

- Your order will include installation brackets specific to your shade.
 - The number of installation brackets required varies with shade width, as shown in the tables below.

CAUTION: Keep the “Do not remove until installation” paper wrap in place, until the shade is completely installed. These instructions will remind you when to remove the wrap.

Standard Cordless Shades

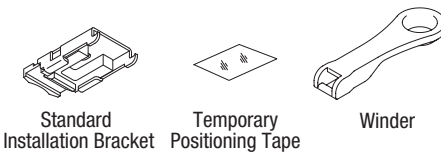

Standard Cordless Shades	
Shade Width	Brackets Required
12" – 55"	2
55½" – 79"	3

Cassette Cordless Shades

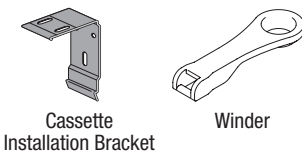

Cassette Cordless Shades	
Shade Width	Brackets Required
Up to 36"	2
36½" – 72"	3
72½" – 90"	4
90½" – 120"	5

INSTALLATION

Mounting Types and Window Terminology

If the installation brackets are mounted correctly, the rest of the installation process will follow easily. To prepare for this important first step, review the mounting types and basic window terminology illustrated below.

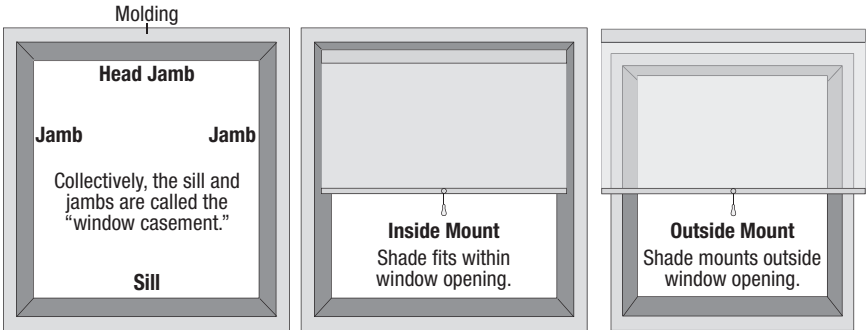

■ Refer to the appropriate page below based on your order:

- **Inside or Ceiling Mount for Standard Shades, see below.**
- **Outside Mount for Standard Shades, see page 5.**
- **Inside or Ceiling Mount for Cassette Shades, see page 6.**
- **Outside Mount for Cassette Shades, see page 7.**

Mount the Installation Brackets — Inside or Ceiling Mount for Standard Shades

IMPORTANT: To ensure the bracket is mounted properly, the white tab should be toward the room.

■ Mark $1\frac{1}{2}$ " – 3" from each jamb for bracket location.

- If more than two installation brackets came with your order, space additional bracket(s) evenly between the two end brackets and mark their location. Mount into wood whenever possible.

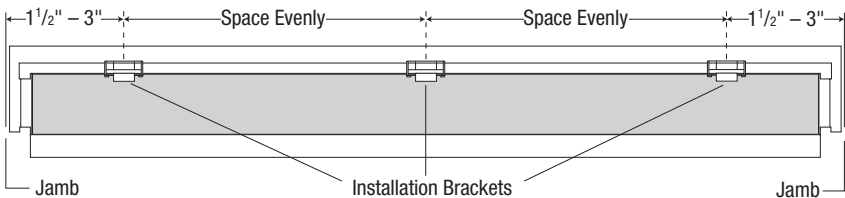

- Center the brackets on your marks and mark the screw holes.
 - The minimum depth required for mounting is $1\frac{5}{8}$ ". For fully recessed mounting, the mounting depth varies with the diameter of the fabric roll when the shade is fully raised.
- Use a $\frac{3}{32}$ " drill bit to drill holes for the mounting screws.

IMPORTANT: Use drywall anchors when mounting into drywall. Drywall anchors are not provided.
- Attach the installation brackets using the screws provided.
 - If necessary, use the temporary positioning tape to position the brackets.

IMPORTANT: The front edges of the installation brackets must be level and aligned to each other.
- Proceed to "Install the Shade" on page 8.

Mount the Installation Brackets — Outside Mount for Standard Shades

- Center the mounting profile over the window opening at the desired height. Use a pencil to lightly mark each end of the mounting profile.
 - Alternatively, measure the width of the mounting profile and use that width to mark the mounting profile end points over the window opening.

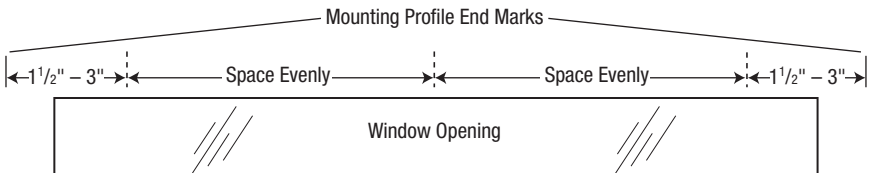

- Mark $1\frac{1}{2}$ " – 3" from each end of the mounting profile.
 - If more than two installation brackets came with your order, space additional bracket(s) evenly between the two end brackets and mark their location. Mount into studs whenever possible.
- Center the brackets on your marks and mark the screw holes.

IMPORTANT: The rear of the brackets must be flush against a flat mounting surface. Do not mount brackets on curved molding.
- Use a $\frac{3}{32}$ " drill bit to drill holes for the mounting screws.

IMPORTANT: Use drywall anchors when mounting into drywall. Drywall anchors are not provided.

INSTALLATION

- Attach the installation brackets using the screws provided.

IMPORTANT: The front edges of the installation brackets must be level and aligned to each other.

- Proceed to “Install the Shade” on page 8.

Mount the Installation Brackets — Inside or Ceiling Mount for Cordless Cassette

- Mark 2" in from each jamb for bracket location.
 - If more than two installation brackets came with your order, space additional bracket(s) evenly between the two end brackets and mark their location. Mount into studs whenever possible.

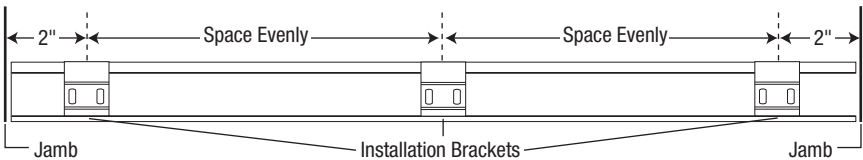

- Center the brackets on your marks and mark the screw holes.
 - The minimum depth required for mounting is 2¼". For fully recessed mounting, 4¼" is required.
- Use a 3/32" drill bit to drill holes for the mounting screws.

IMPORTANT: Use drywall anchors when mounting into drywall. Drywall anchors are not provided.

- Attach the installation brackets using the screws provided.

IMPORTANT: The front edges of the installation brackets must be level and aligned to each other.

- Proceed to “Install the Shade” on page 8.

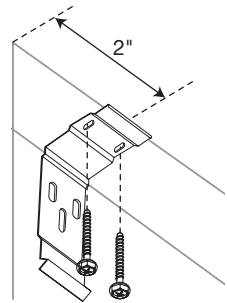

Mount the Installation Brackets — Outside Mount for Cordless Cassette

- Center the cassette over the window opening at the desired height. Use a pencil to lightly mark each end of the cassette.
 - Alternatively, measure the width of the cassette and use that width to mark the mounting profile end points over the window opening.

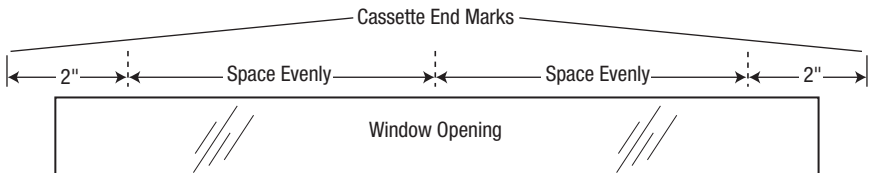

- Mark 2" from each end of the cassette.
 - If more than two installation brackets came with your order, space additional bracket(s) evenly between the two end brackets and mark their location. Mount into studs whenever possible.
- Center the brackets on your marks and mark the screw holes.

IMPORTANT: The rear of the brackets must be flush against a flat mounting surface. Do not mount brackets on curved molding.

- Use a $\frac{3}{32}$ " drill bit to drill holes for the mounting screws.

IMPORTANT: Use drywall anchors when mounting into drywall. Drywall anchors are not provided.

- Attach the installation brackets using the screws provided.

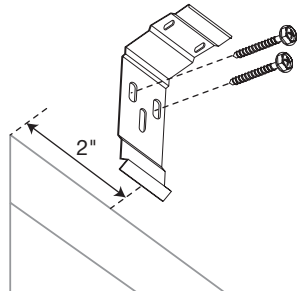

IMPORTANT: The front edges of the installation brackets must be level and aligned to each other.

INSTALLATION

Install the Shade

Standard Installation

The groove on the top of the mounting profile fits into the hooks on the installation brackets.

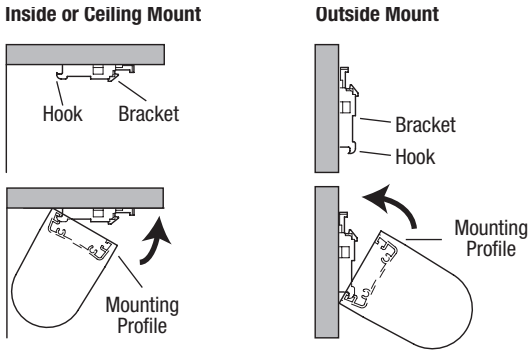

- Install the shade into the installation brackets.
 - Hold the shade so the bottom bar fabric side faces you.
 - Hook the back groove of the mounting profile onto the hooks of the installation brackets.
 - Rotate the mounting profile toward the white tabs of the installation brackets. Push the set bar until tabs lock into place. You will hear a loud click when each bracket is securely in place.

Cassette Installation

- Angle the cassette back and then align the cassette under the front lip of the bracket.
- Push the cassette back to snap it into the lower lip of the bracket.

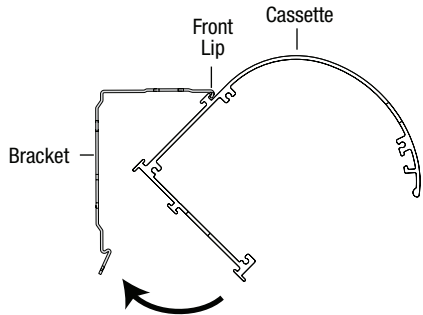

Install the Shade Pull

The shade pull is not attached when delivered.

- Detach the screw from the shade pull. Insert the screw through the bottom bar so the screw head is on the back side of the bottom bar.
- Attach the shade pull with the screw.
- After the shade is properly installed, remove the “Do not remove until installation” paper from the roll.

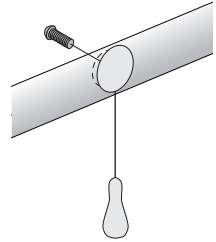

Attach the Standard Hold-Down Brackets (Optional)

The standard hold-down brackets may be used with outside mount shades only.

- With the shade fully lowered, insert the pin on the hold-down bracket into the hole on the bottom rail end cap.
- Mark the hole locations on the mounting surface.
- Center the hold-down brackets over the mounting hole locations and check their alignment. Attach using two screws.

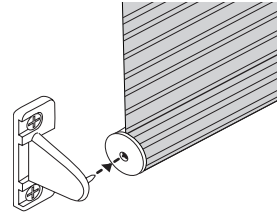

IMPORTANT: Disconnect the bottom rail from the hold-down brackets to raise the shade.

INSTALLATION

Attach the Magnetic Hold-Down Brackets (Optional)

- Lower the shade.
- Place the magnetic hold-down bracket onto the bottom rail just inside the end cap, oriented as shown.
- Hold the bracket while opening and closing the shade slightly (it may be necessary to have someone assist you). Adjust the bracket to the best overall position using the mounting options shown below.

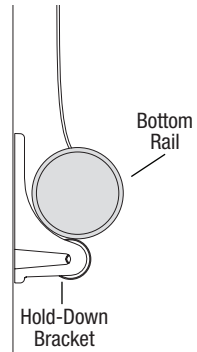

Outside Mount



Preferred



Alternate

Inside Mount



Preferred



Alternate

- Mark the screw location.
 - The screw should be placed in the middle of the channel. This will allow for adjustment.
- Drill the screw holes using a $\frac{3}{32}$ " drill bit.
- Attach the hold-down brackets to the mounting surface using the screws provided.
- If necessary, adjust the bracket location in the channel for best operation.

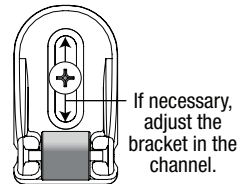

Operate the Shade

Lowering the Shade

- Pull down and release. The shade stops where released.

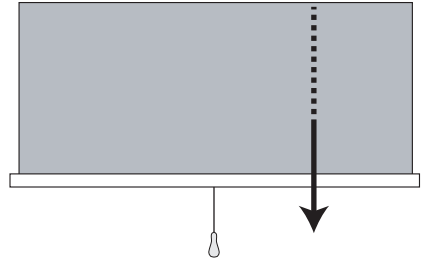

Raising the Shade

- Pull the shade down about an inch and release. The shade rises and stops.

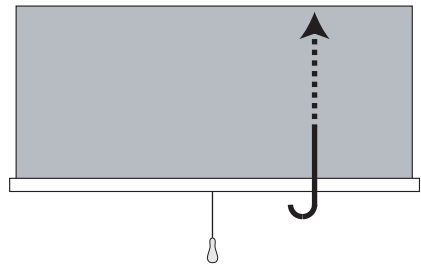

Shade Adjustment

Stop Height Adjustment

The upper level stop height can be adjusted on shades wider than 24". Generally, the shade stops when it is completely rolled up. By using a stop controller, the shade can be adjusted to stop before reaching the top. The stop controller is also useful for aligning multiple side-by-side shades.

- Completely roll up the shade.
- Turn the dial clockwise to lower the fabric level or dial counter-clockwise to raise the fabric level.
- Lower and raise the shade. Repeat the previous step until the stop height is at the desired level.

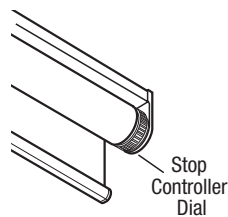

CAUTION: When the shade is pulled too hard, the bottom of the shade may flip over the top of the roller tube. To fix this, turn the roller tube manually by hand.

OPERATION

Speed Adjustment

If slight changes in the speed are desired:

- Completely raise the shade.
- Turn the left side holder counter-clockwise until it stops.
- Remove the roller from the mounting profile by pulling it out from the right side holder.

IMPORTANT: Remove the shade slowly with both hands.

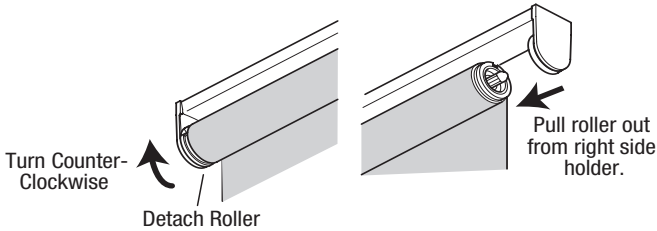

- Lay shade on a flat surface.
- Place the winder onto the black knob on the left side of the roller.
- For faster roll-up:

- Turn 1-2 times clockwise as pictured while pulling the winder.

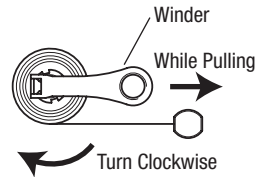

- For slower roll-up:

- While pulling the winder, turn a half-turn clockwise, then turn 1-2 times counter-clockwise.

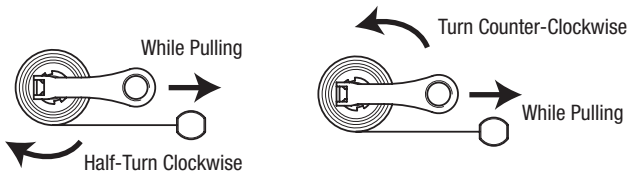

- Replace the roller by aligning it in the right side holder.
- Slide the left side black knob into the side holder. The red side of the knob should be facing up.
- Turn the left side holder clockwise until it stops.

WARNING: The winder does not turn if it is not pulled. Do not turn it more than two turns. Hold the winder securely, otherwise it may slip from the knob and cause injury.

Troubleshooting

Problem	Solution
The shade does not roll up, or it rolls too slowly.	<ul style="list-style-type: none"> ■ Check that the mounting brackets are level. ■ Roll-up speed can be adjusted. See “Speed Adjustment” on page 12.
The shade does not lower.	<ul style="list-style-type: none"> ■ Check that the window is square by measuring the diagonals. ■ Check that the left side holder dial is closed. The shade will not operate if it is in the open position. <p>CAUTION: Do not disassemble or modify the mechanism inside the roll tube.</p>
I have several shades, and the side holders are different sizes.	<ul style="list-style-type: none"> ■ Shade holder size is determined by the length of the shade and size of the roll.

Removing the Shade (If Necessary)

Standard Cordless Shade

- Fully raise the shade.
- While holding the shade, push in the white tab on each bracket to release.

Cordless with Cassette Shade

- Insert the tip of a flat head screwdriver into the screwdriver slot provided on the bracket.
- Press down to release the cassette.
- Roll the cassette forward and then down to remove.

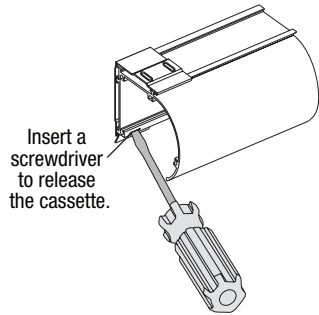

Cleaning Procedures

The following options are available if your shade needs cleaning.

Dusting

- Regular light dusting with a feather duster or soft cloth is all the cleaning that is needed in most circumstances.

Vacuuming

- Use a hand-held vacuum with low suction for more thorough dust removal.

CAUTION: Do not clean with harsh detergents.

For more cleaning methods specific to your roller shade fabric, please consult your Hunter Douglas dealer.

LIFETIME GUARANTEE

The Hunter Douglas® Lifetime Guarantee is an expression of our desire to provide a thoroughly satisfying experience when selecting, purchasing and living with your window fashion products. If you are not thoroughly satisfied, simply contact Hunter Douglas at (888) 501-8364 or visit hunterdouglas.com. In support of this policy of consumer satisfaction, we offer our Lifetime Limited Warranty as described below.

COVERED

BY A LIFETIME LIMITED WARRANTY

- Hunter Douglas window fashion products are covered for defects in materials, workmanship or failure to operate for as long as the original retail purchaser owns the product (unless shorter periods are provided below).
- All internal mechanisms.
- Components and brackets.
- Fabric delamination.
- Operational cords for a full 7 years from the date of purchase.
- Repairs and/or replacements will be made with like or similar parts or products.
- Hunter Douglas motorization components are covered for 5 years from the date of purchase.

NOT COVERED

BY A LIFETIME LIMITED WARRANTY

- Any conditions caused by normal wear and tear.
- Abuse, accidents, misuse or alterations to the product.
- Exposure to the elements (sun damage, wind, water/moisture) and discoloration or fading over time.
- Failure to follow our instructions with respect to measurement, proper installation, cleaning or maintenance.
- Shipping charges, cost of removal and reinstallation.

Hunter Douglas (or its licensed fabricator/distributor) will repair or replace the window fashion product or components found to be defective.

TO OBTAIN WARRANTY SERVICE

1. Contact your original dealer (place of purchase) for warranty assistance.
2. Visit hunterdouglas.com for additional warranty information, frequently asked questions and access to service locations.
3. Contact Hunter Douglas at (888) 501-8364 for technical support, certain parts free of charge, for assistance in obtaining warranty service or for further explanation of our warranty.

NOTE: In no event shall Hunter Douglas or its licensed fabricators/distributors be liable or responsible for incidental or consequential damages or for any other indirect damage, loss, cost or expense. Some states do not allow the exclusion or limitation of incidental or consequential damages, so the above exclusion or limitation may not apply to you. This warranty gives you specific legal rights, and you may also have other rights which vary from state to state.

Different warranty periods and terms apply for commercial products and applications.

HunterDouglas

hunterdouglas.com

